



MEDICO

TECHNOLOGIES



Surgical

Instruments

Catalog **2021**



LIVER GALLBLADDER KIDNEY UROLOGY INSTRUMENTS

Kidney Stone Forceps
Nierensteinzangen
Pinzas para cálculos renales
Pinces pour les calculs du bassinet
Pinze per calcoli renali

Vasectomy Dissecting Forcep

| Catalog # | Size |
|--------------|------|
| MT-UR-15-100 | N/A |



Vasectomy Fixation Clamp

| Catalog # | Size |
|--------------|------|
| MT-UR-15-101 | N/A |



Randall Kidney Stone Forcep

Fig. 1

| Catalog # | Size |
|--------------|------------|
| MT-UR-15-102 | 23 cm (9") |

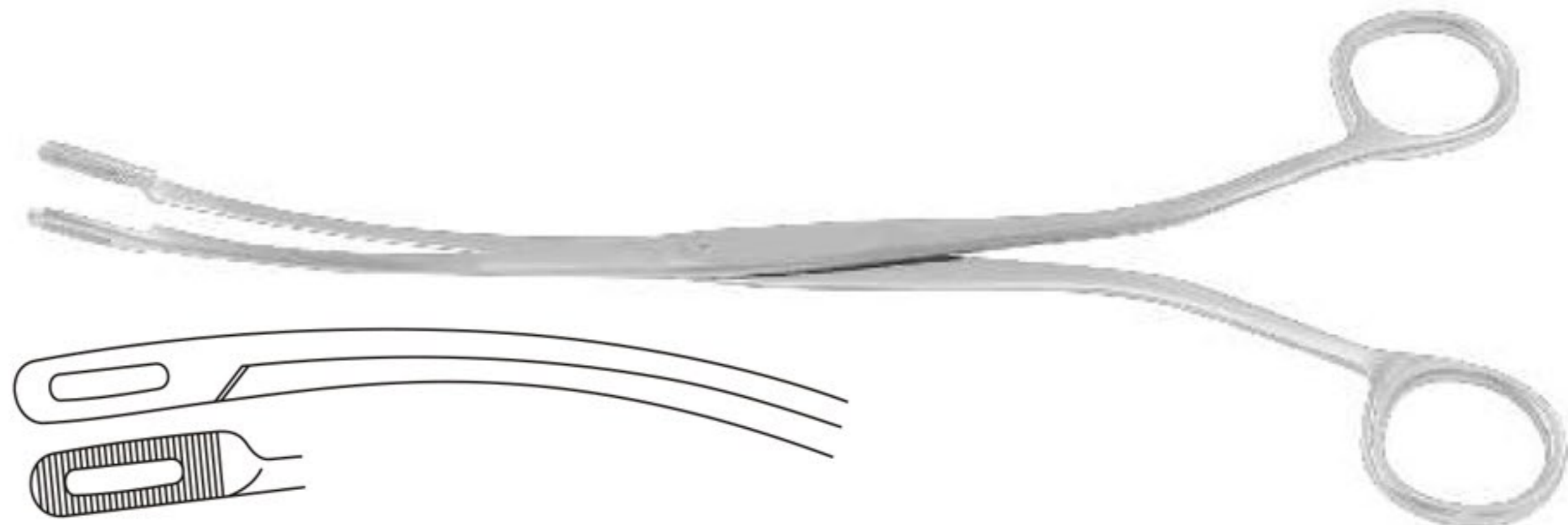

Randall Kidney Stone Forcep

Fig. 2

| Catalog # | Size |
|--------------|----------------|
| MT-UR-15-103 | 21 cm (8 1/4") |

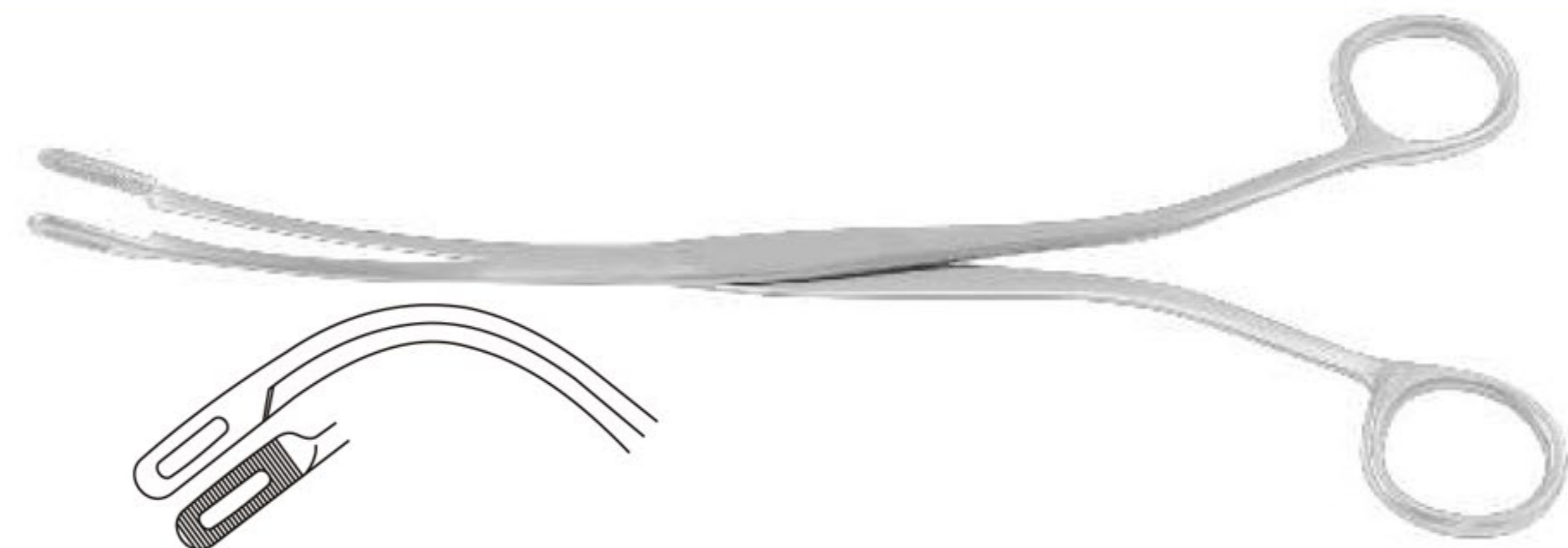

Randall Kidney Stone Forcep

Fig. 3

| Catalog # | Size |
|--------------|----------------|
| MT-UR-15-104 | 19 cm (7 1/2") |

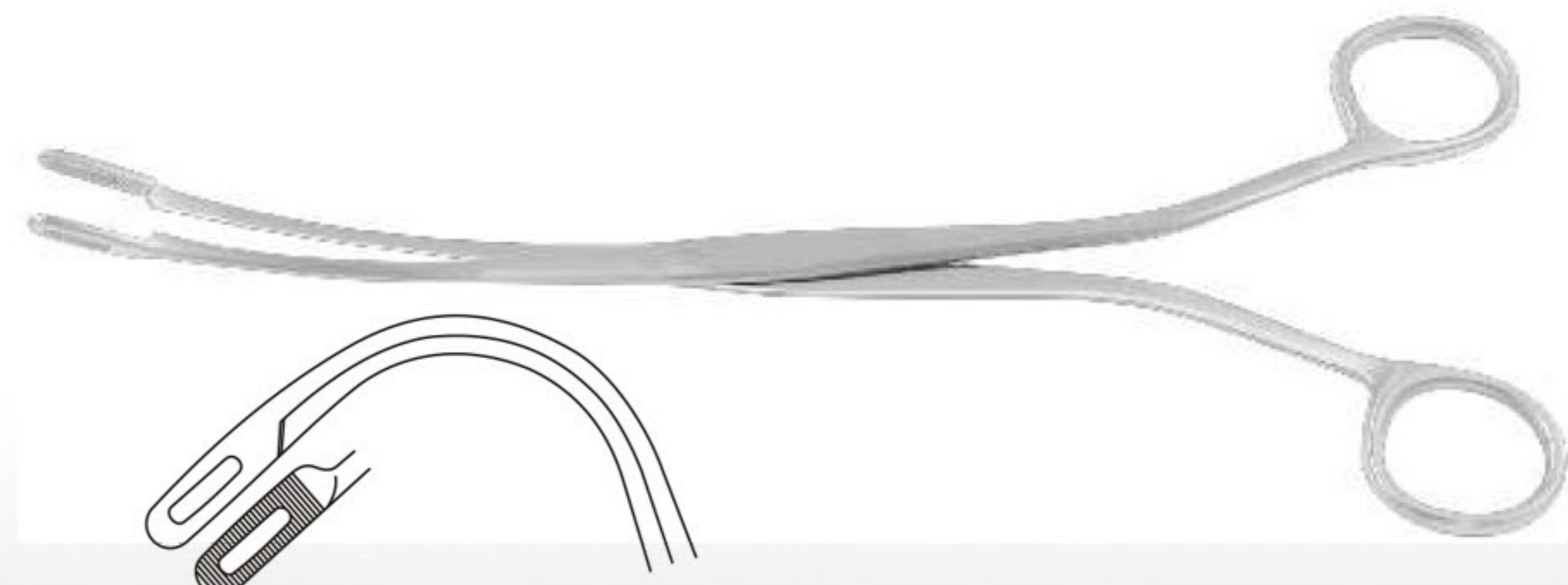



LIVER GALLBLADDER KIDNEY UROLOGY INSTRUMENTS

Kidney Stone Forceps
Nierensteinzangen
Pinzas para cálculos renales
Pinces pour les calculs du bassinot
Pinze per calcoli renali

Randall Kidney Stone Forcep

Fig. 4

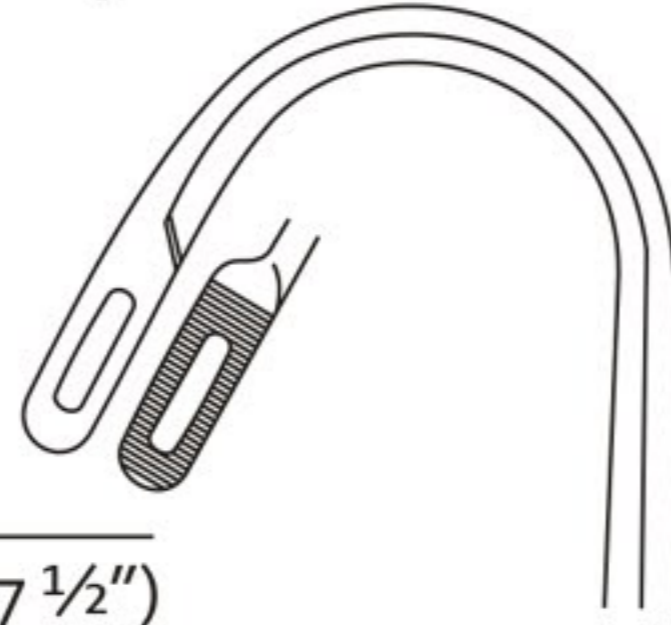

| Catalog # | Size |
|--------------|------------------|
| MT-UR-15-105 | 18.5 cm (7 1/2") |



Randall Kidney Stone Forcep

Fig. 5

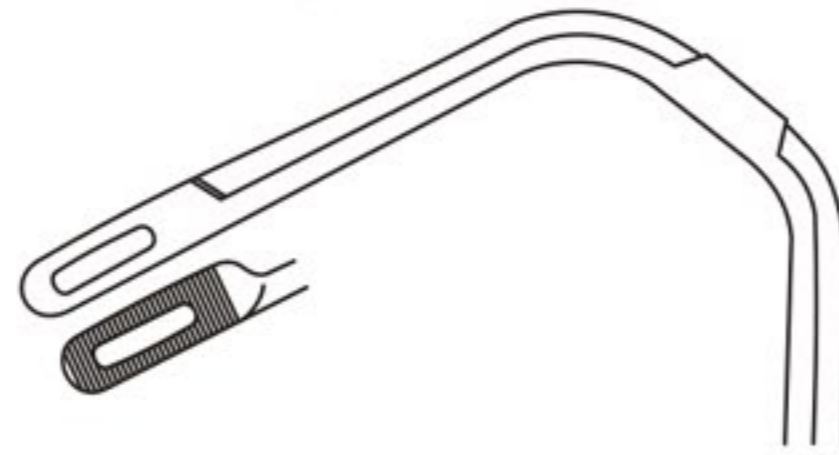

| Catalog # | Size |
|--------------|----------------|
| MT-UR-15-106 | 19 cm (7 1/2") |



Randall Kidney Stone Forcep

Fig. 6

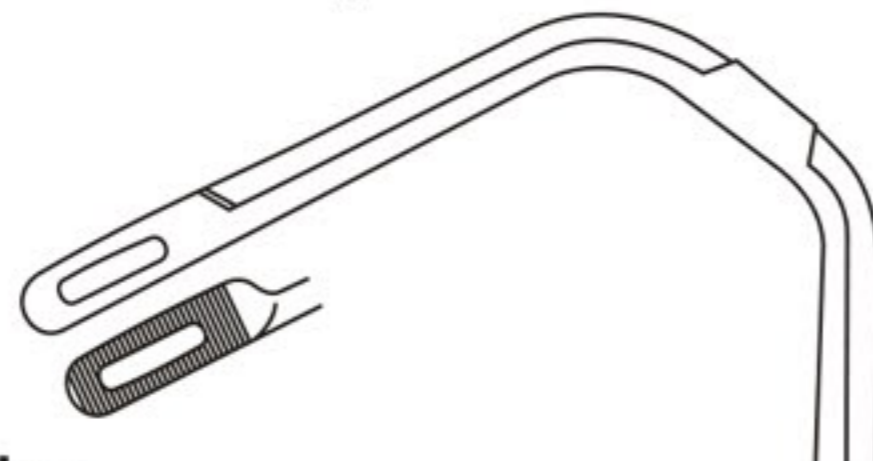

| Catalog # | Size |
|--------------|----------------|
| MT-UR-15-107 | 19 cm (7 1/2") |



Randall Kidney Stone Forcep

Fig. 1, Slender Pattern

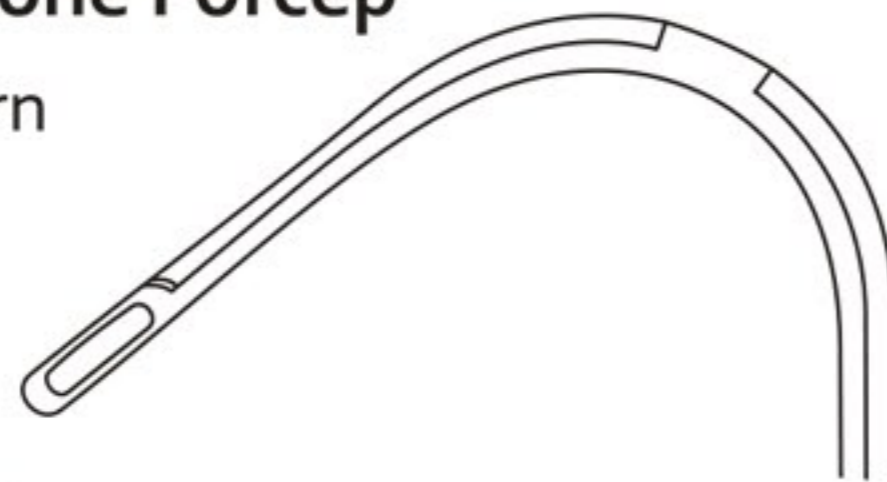

| Catalog # | Size |
|--------------|------------|
| MT-UR-15-108 | 23 cm (9") |



Randall Kidney Stone Forcep

Fig. 2, Slender Pattern

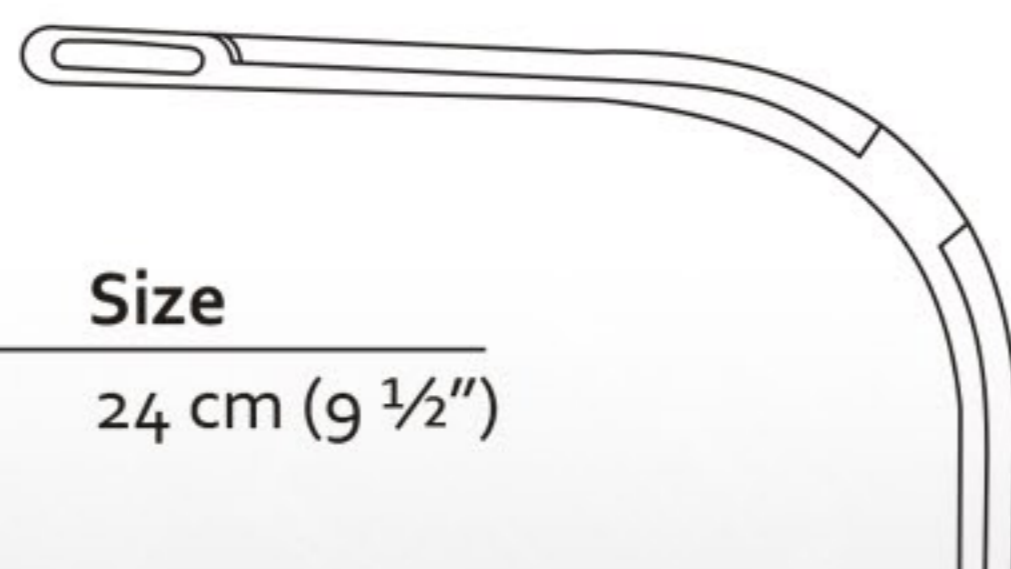

| Catalog # | Size |
|--------------|----------------|
| MT-UR-15-109 | 24 cm (9 1/2") |





LIVER GALLBLADDER KIDNEY UROLOGY INSTRUMENTS

Kidney Stone Forceps
Nierensteinzangen
Pinzas para cálculos renales
Pinces pour les calculs du bassin
Pinze per calcoli renali

Heiming Kidney Stone Forcep

Fig. 1

| Catalog # | Size |
|--------------|----------------|
| MT-UR-15-110 | 16 cm (6 1/4") |

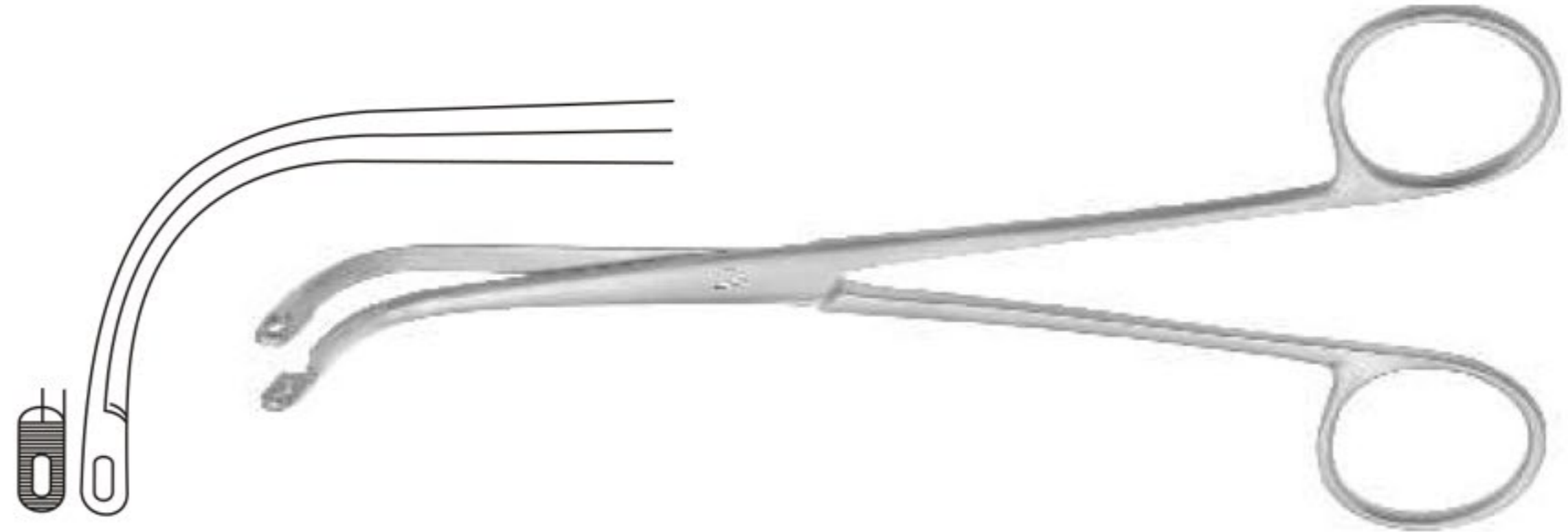

Heiming Kidney Stone Forcep

Fig. 2

| Catalog # | Size |
|--------------|----------------|
| MT-UR-15-111 | 17 cm (6 3/4") |

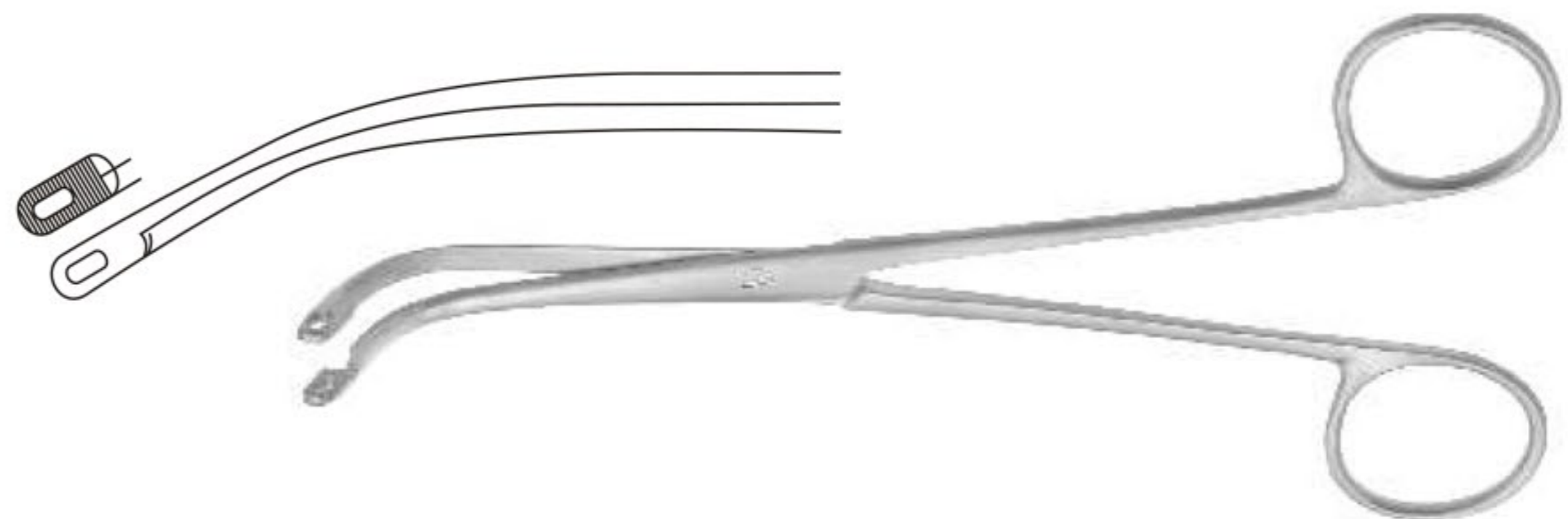

Elsaesser Nephrostomy Forcep

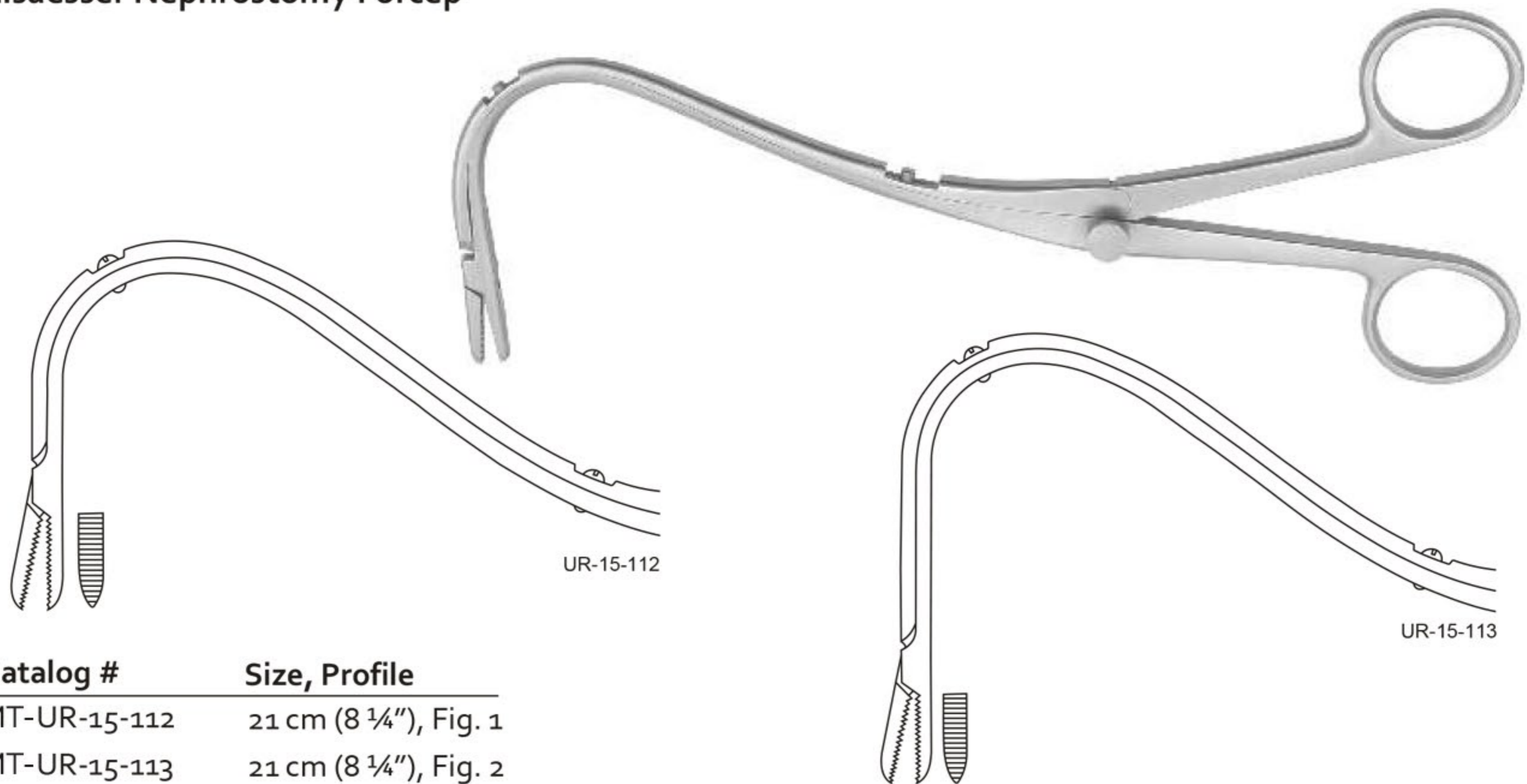

| Catalog # | Size, Profile |
|--------------|------------------------|
| MT-UR-15-112 | 21 cm (8 1/4"), Fig. 1 |
| MT-UR-15-113 | 21 cm (8 1/4"), Fig. 2 |

Bakes Gall Duct Dilators

Set of 13 Ref: UR-150-01 to UR-150-13



| Catalog # | Size |
|--------------|------|
| MT-UR-15-114 | N/A |



LIVER GALLBLADDER KIDNEY UROLOGY INSTRUMENTS

Gall Duct Dilators
 Gallenkanaldilatatoren
 Dilatadores para conducto biliar
 Dilatateurs pour les voies biliaires
 Dilatatori per condotti biliari

Bakes Gall Duct Dilator

| Catalog # | Size, Diameter, Profile |
|--------------|-----------------------------------|
| MT-UR-15-115 | 32 cm (12 1/2"), Ø 1 mm, Fig. 1 |
| MT-UR-15-116 | 32 cm (12 1/2"), Ø 2 mm, Fig. 2 |
| MT-UR-15-117 | 32 cm (12 1/2"), Ø 3 mm, Fig. 3 |
| MT-UR-15-118 | 32 cm (12 1/2"), Ø 8 mm, Fig. 4 |
| MT-UR-15-119 | 32 cm (12 1/2"), Ø 6 mm, Fig. 5 |
| MT-UR-15-120 | 32 cm (12 1/2"), Ø 7 mm, Fig. 6 |
| MT-UR-15-121 | 32 cm (12 1/2"), Ø 8 mm, Fig. 7 |
| MT-UR-15-122 | 32 cm (12 1/2"), Ø 9 mm, Fig. 8 |
| MT-UR-15-123 | 32 cm (12 1/2"), Ø 10 mm, Fig. 9 |
| MT-UR-15-124 | 32 cm (12 1/2"), Ø 11 mm, Fig. 10 |
| MT-UR-15-125 | 32 cm (12 1/2"), Ø 12 mm, Fig. 11 |
| MT-UR-15-126 | 32 cm (12 1/2"), Ø 13 mm, Fig. 12 |
| MT-UR-15-127 | 32 cm (12 1/2"), Ø 13 mm, Fig. 13 |

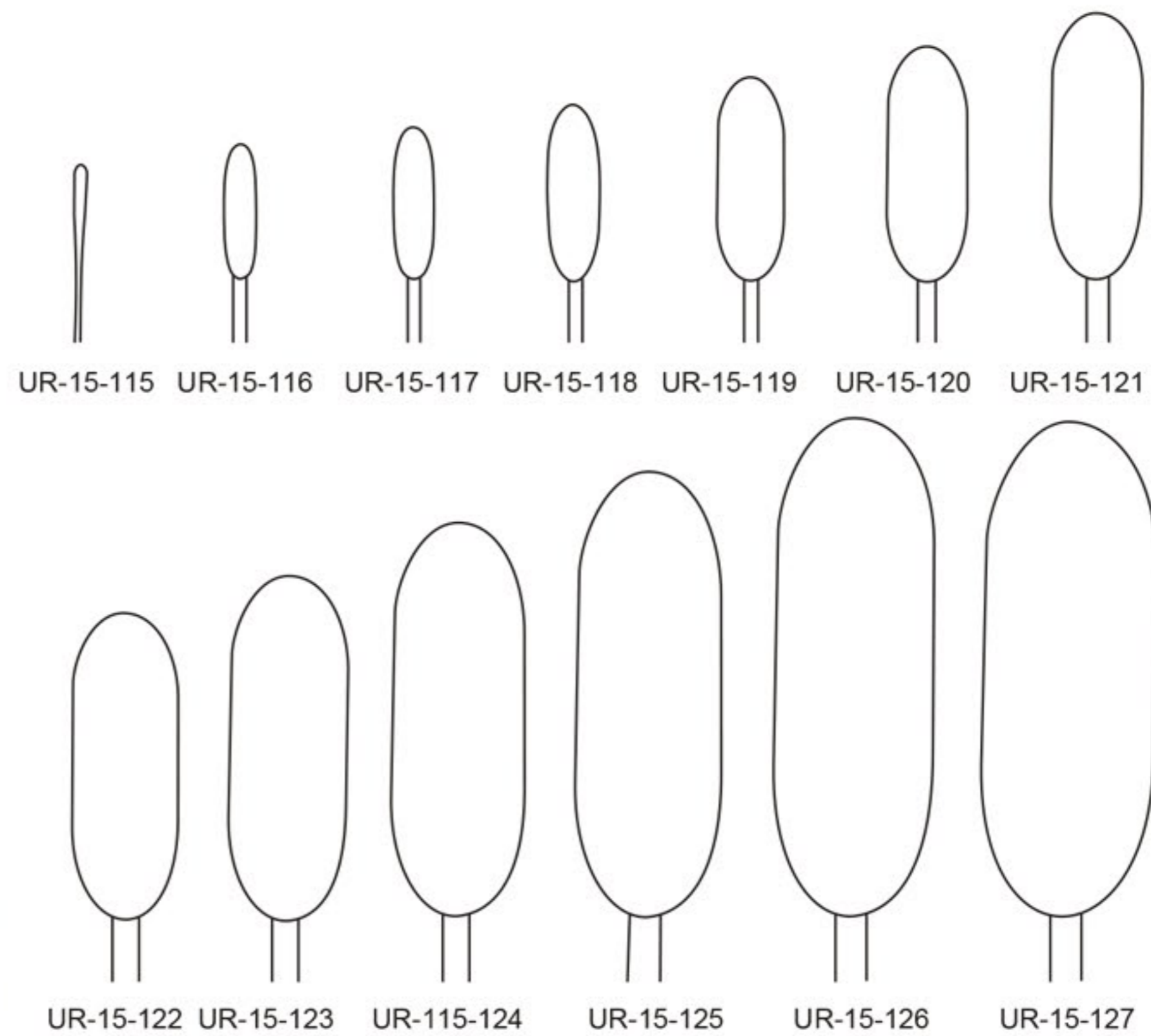

Bakes Gall Stone Forcep Straight



| Catalog # | Size |
|--------------|----------------|
| MT-UR-15-128 | 21 cm (8 1/4") |

Bakes Gall Stone Forcep Curved

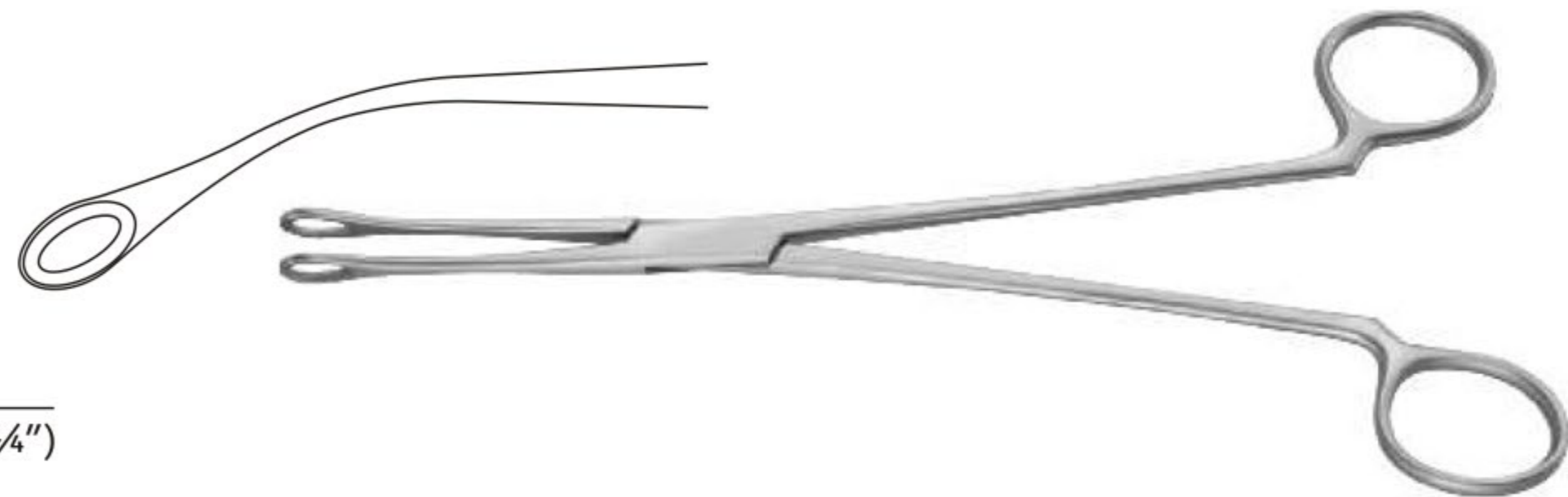

| Catalog # | Size |
|--------------|----------------|
| MT-UR-15-129 | 21 cm (8 1/4") |

Mayo-Bakes Gall Stone Forcep Straight



| Catalog # | Size |
|--------------|----------------|
| MT-UR-15-130 | 21 cm (8 1/4") |



LIVER GALLBLADDER KIDNEY UROLOGY INSTRUMENTS

Gall Stone Forceps
Gallensteinzangen
Pinzas para cálculos biliares
Pinces pour calculs biliaires
Pinze per calcoli biliari

Mayo-Bakes Gall Stone Forcep

Curved



| Catalog # | Size |
|--------------|----------------|
| MT-UR-15-131 | 21 cm (8 1/4") |

Mixer Gall Stone Forcep



| Catalog # | Size |
|--------------|----------------|
| MT-UR-15-132 | 22 cm (8 3/4") |

Desjardins Gall Stone Forcep

Fig. 1



| Catalog # | Size |
|--------------|------------|
| MT-UR-15-133 | 23 cm (9") |

Desjardins Gall Stone Forcep

Fig. 2



| Catalog # | Size |
|--------------|------------|
| MT-UR-15-134 | 23 cm (9") |



LIVER GALLBLADDER KIDNEY UROLOGY INSTRUMENTS

Prostatic Retractors
 Prostatahaken
 Separadores para próstata
 Ecarteurs prostatiques
 Divaricatori prostatici

Luer-Koerte Gall Stone Scoop

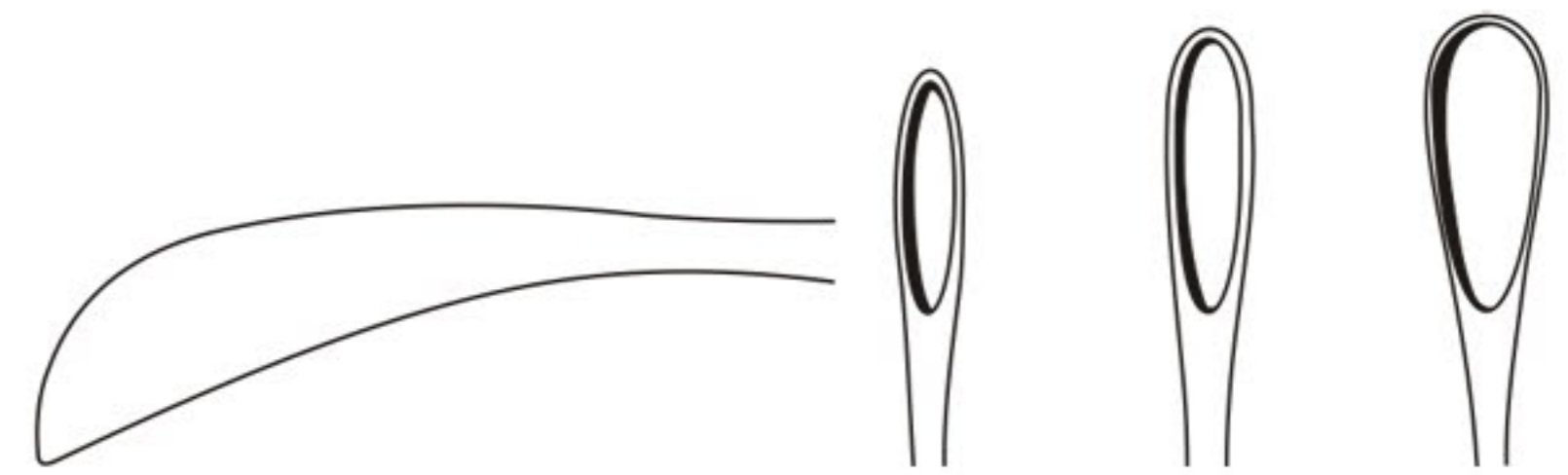

| Catalog # | Size, Scoop Size, Profile |
|--------------|-------------------------------------|
| MT-UR-15-135 | 32 cm (12 1/2"), Ø 2.7 mm, Fig. 000 |
| MT-UR-15-136 | 32 cm (12 1/2"), Ø 3.4 mm, Fig. 00 |
| MT-UR-15-137 | 32 cm (12 1/2"), Ø 4.3 mm, Fig. 0 |
| MT-UR-15-138 | 32 cm (12 1/2"), Ø 5.5 mm, Fig. 1 |
| MT-UR-15-139 | 32 cm (12 1/2"), Ø 6.6 mm, Fig. 2 |
| MT-UR-15-140 | 32 cm (12 1/2"), Ø 8.0 mm, Fig. 3 |
| MT-UR-15-141 | 32 cm (12 1/2"), Ø 11.0 mm, Fig. 4 |
| MT-UR-15-142 | 32 cm (12 1/2"), Ø 15.0 mm, Fig. 5 |

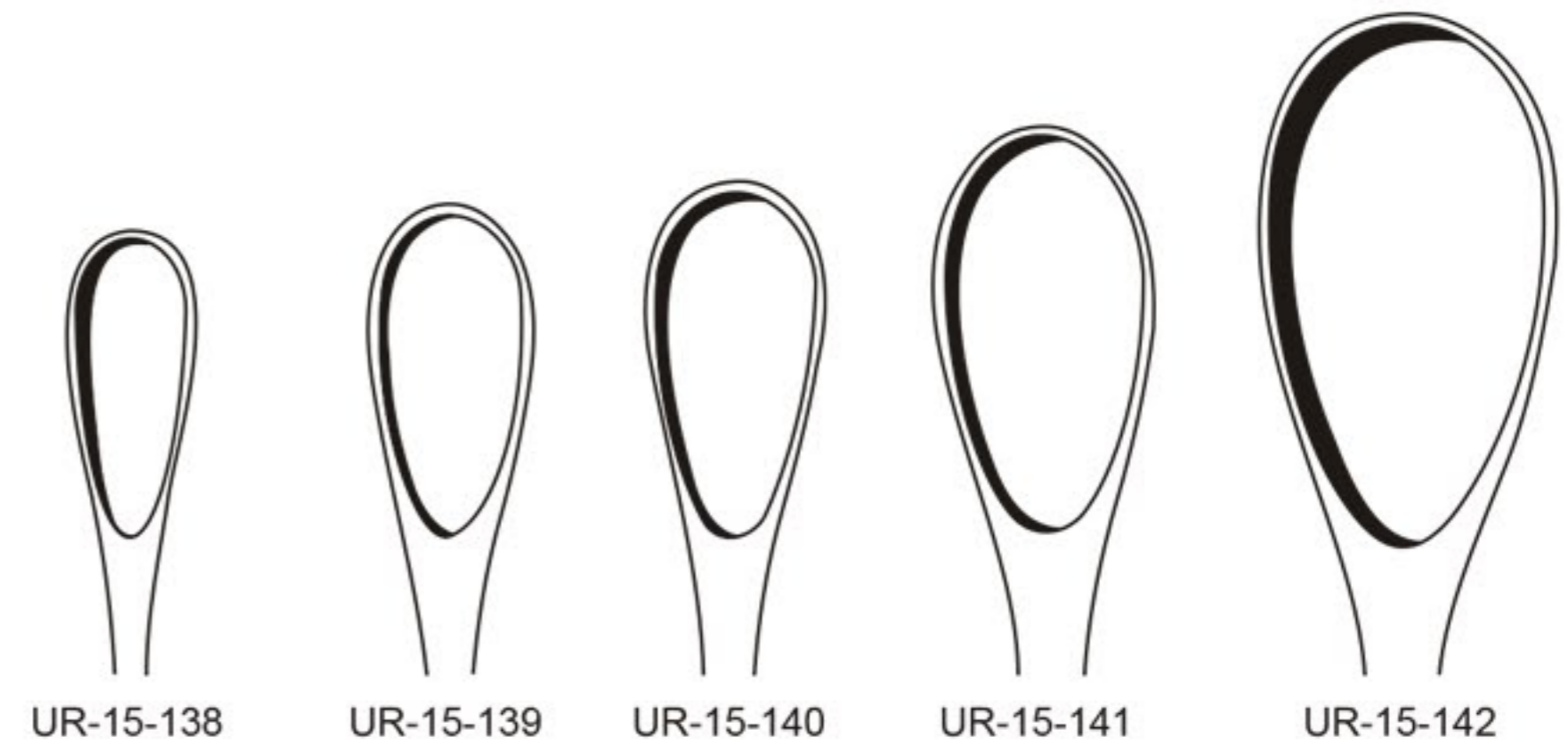

Young Prostatic Retractor

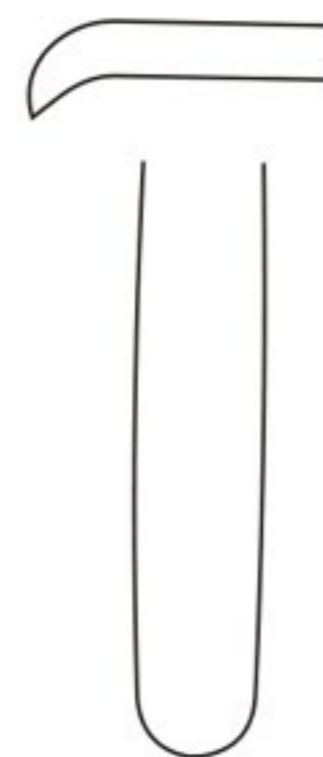

| Catalog # | Size |
|--------------|----------------|
| MT-UR-15-143 | 22 cm (8 3/4") |

Young Prostatic Retractor



| Catalog # | Size |
|--------------|------------------|
| MT-UR-15-144 | 21.5 cm (8 1/2") |

Young Prostatic Retractor

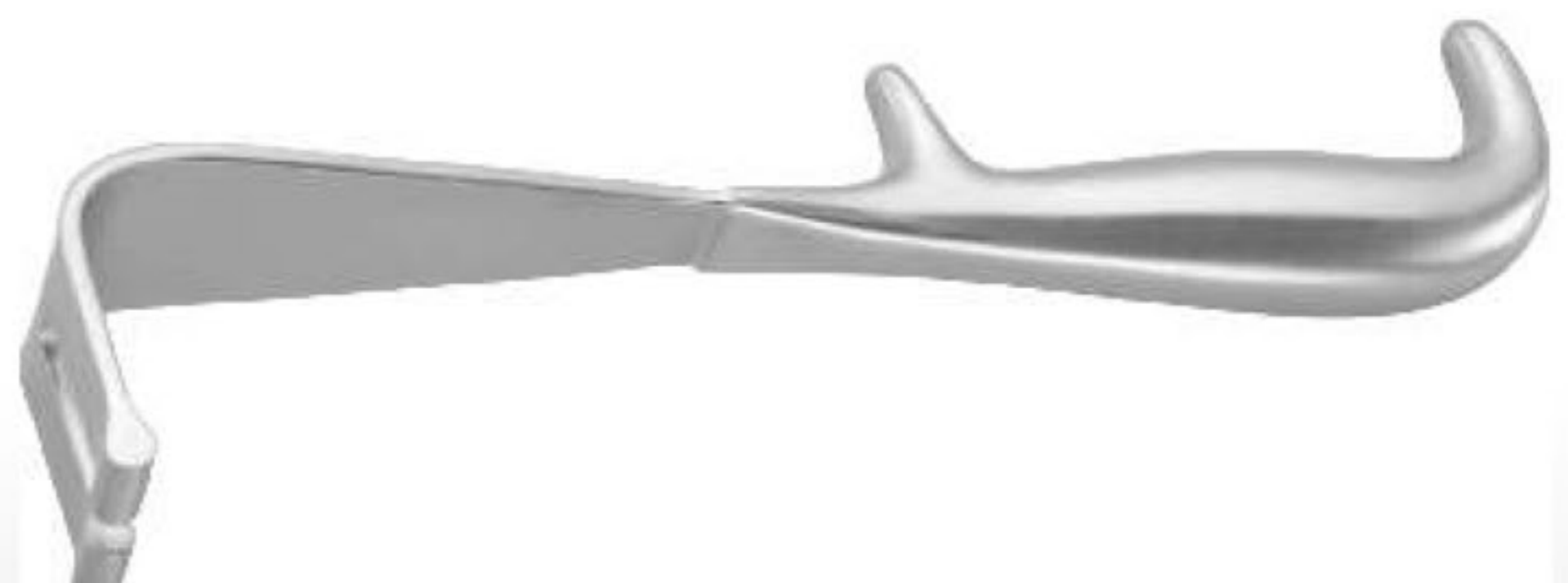

| Catalog # | Size |
|--------------|------------|
| MT-UR-15-145 | 23 cm (9") |



LIVER GALLBLADDER KIDNEY UROLOGY INSTRUMENTS

Capsule Forceps
Kapselasszangen
Pinzas capsulares
Pincers pour saisir les capsules
Pinze per afferrare capsule

Millin Atrauma Capsule Forcep



| Catalog # | Size |
|--------------|------------------|
| MT-UR-15-146 | 24.5 cm (9 1/2") |

Millin Atrauma Capsule Forcep

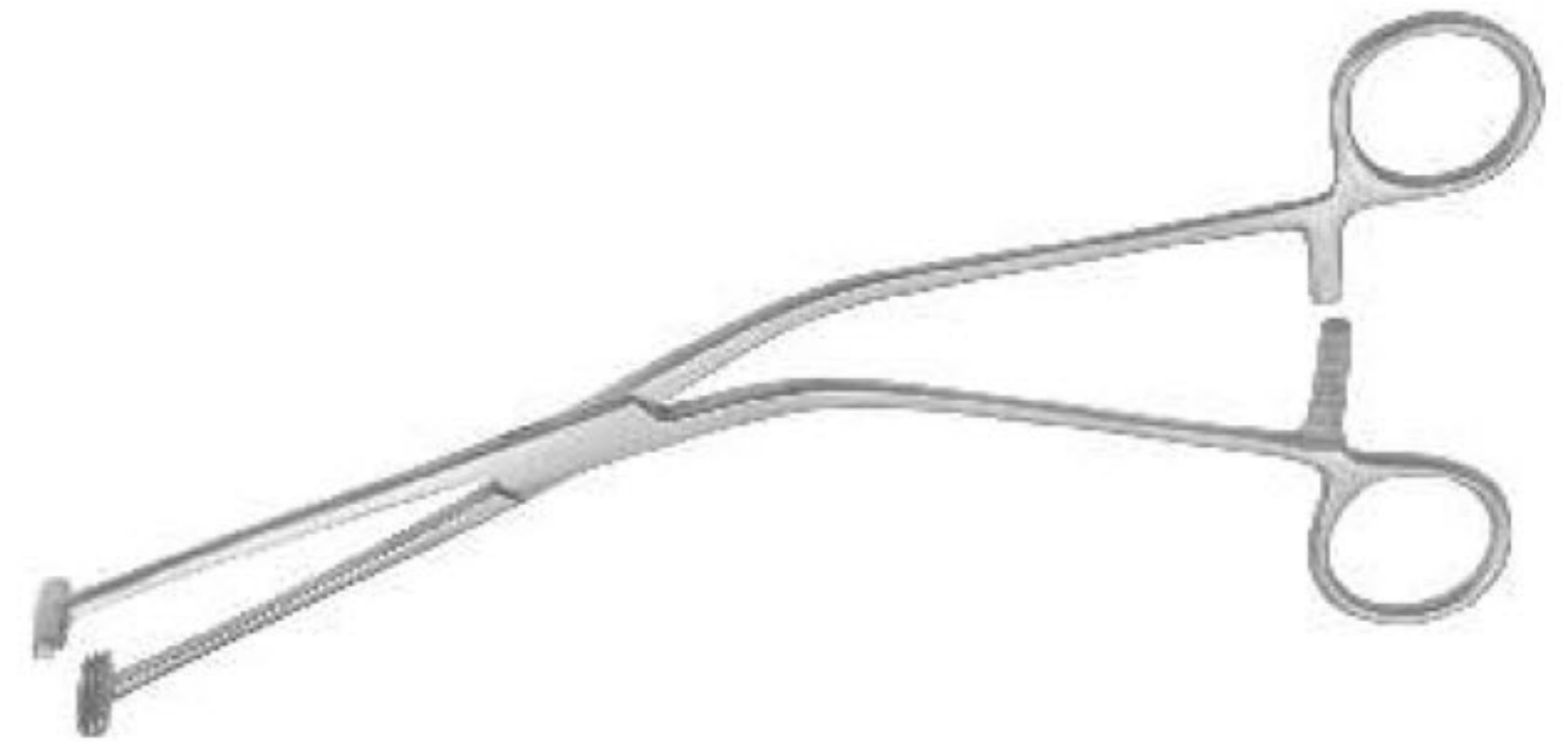
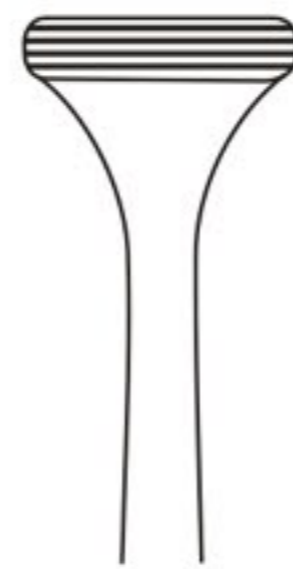

| Catalog # | Size |
|--------------|------------------|
| MT-UR-15-147 | 22.5 cm (8 3/4") |

Millin Capsule Forcep

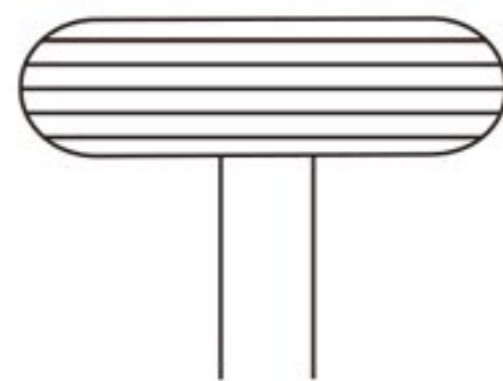

| Catalog # | Size |
|--------------|------------------|
| MT-UR-15-148 | 24.5 cm (9 1/2") |

Millin Capsule Forcep



| Catalog # | Size |
|--------------|----------------|
| MT-UR-15-149 | 22 cm (8 3/4") |

Van Buren Urethral Sound / Dilating Bougie

Set of 15 Ref: UR-501-08 to UR-501-36



| Catalog # | Size |
|--------------|------|
| MT-UR-15-150 | N/A |



LIVER GALLBLADDER KIDNEY UROLOGY INSTRUMENTS

Urethral Sounds
Harnröhrenbougies
Bujías uretrales
Bougies urétrales
Candelette dilatatrici

Van Buren Urethral Sound / Dilating Bougie

| Catalog # | Size, Profile |
|--------------|----------------------------|
| MT-UR-15-151 | 27 cm (10 3/4"), 8 Charr. |
| MT-UR-15-152 | 27 cm (10 3/4"), 10 Charr. |
| MT-UR-15-153 | 27 cm (10 3/4"), 12 Charr. |
| MT-UR-15-154 | 27 cm (10 3/4"), 14 Charr. |
| MT-UR-15-155 | 27 cm (10 3/4"), 16 Charr. |
| MT-UR-15-156 | 27 cm (10 3/4"), 18 Charr. |
| MT-UR-15-157 | 27 cm (10 3/4"), 20 Charr. |
| MT-UR-15-158 | 27 cm (10 3/4"), 22 Charr. |
| MT-UR-15-159 | 27 cm (10 3/4"), 24 Charr. |
| MT-UR-15-160 | 27 cm (10 3/4"), 26 Charr. |
| MT-UR-15-161 | 27 cm (10 3/4"), 28 Charr. |
| MT-UR-15-162 | 27 cm (10 3/4"), 30 Charr. |
| MT-UR-15-163 | 27 cm (10 3/4"), 32 Charr. |
| MT-UR-15-164 | 27 cm (10 3/4"), 34 Charr. |
| MT-UR-15-165 | 27 cm (10 3/4"), 36 Charr. |



Guyon Urethral Sound / Dilating Bougie

Set of 24

| Catalog # | Size |
|--------------|------|
| MT-UR-15-166 | N/A |

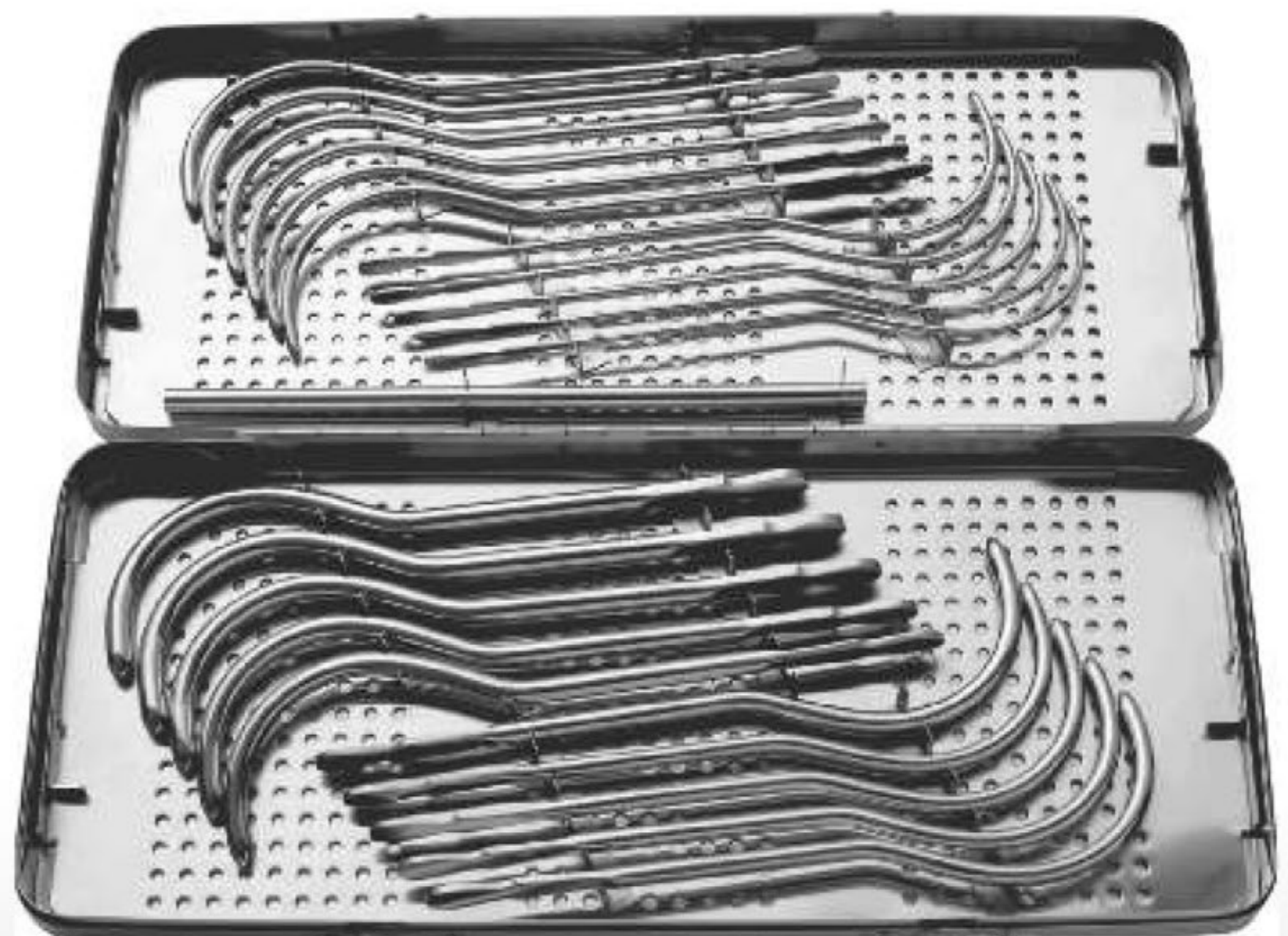



LIVER GALLBLADDER KIDNEY UROLOGY INSTRUMENTS

Urethral Sounds
Harnröhrenbougies
Bujías uretrales
Bougies urétrales
Candelette dilatatrici

Guyon Urethral Sound / Dilating Bougie

| Catalog # | Size, Profile |
|--------------|------------------------------|
| MT-UR-15-167 | 26.5 cm (10 1/2"), 10 Charr. |
| MT-UR-15-168 | 26.5 cm (10 1/2"), 11 Charr. |
| MT-UR-15-169 | 26.5 cm (10 1/2"), 12 Charr. |
| MT-UR-15-170 | 26.5 cm (10 1/2"), 13 Charr. |
| MT-UR-15-171 | 26.5 cm (10 1/2"), 14 Charr. |
| MT-UR-15-172 | 26.5 cm (10 1/2"), 15 Charr. |
| MT-UR-15-173 | 26.5 cm (10 1/2"), 16 Charr. |
| MT-UR-15-174 | 26.5 cm (10 1/2"), 17 Charr. |
| MT-UR-15-175 | 26.5 cm (10 1/2"), 18 Charr. |
| MT-UR-15-176 | 26.5 cm (10 1/2"), 19 Charr. |
| MT-UR-15-177 | 26.5 cm (10 1/2"), 20 Charr. |
| MT-UR-15-178 | 26.5 cm (10 1/2"), 21 Charr. |
| MT-UR-15-179 | 26.5 cm (10 1/2"), 22 Charr. |
| MT-UR-15-180 | 26.5 cm (10 1/2"), 23 Charr. |
| MT-UR-15-181 | 26.5 cm (10 1/2"), 24 Charr. |
| MT-UR-15-182 | 26.5 cm (10 1/2"), 25 Charr. |
| MT-UR-15-183 | 26.5 cm (10 1/2"), 26 Charr. |
| MT-UR-15-184 | 26.5 cm (10 1/2"), 27 Charr. |
| MT-UR-15-185 | 26.5 cm (10 1/2"), 28 Charr. |
| MT-UR-15-186 | 26.5 cm (10 1/2"), 30 Charr. |



Female Catheter

| Catalog # | Size, Profile |
|--------------|-----------------------|
| MT-UR-15-187 | 15 cm (6"), 12 Charr. |
| MT-UR-15-188 | 15 cm (6"), 14 Charr. |



Catheter Introducer

| Catalog # | Size |
|--------------|-------------|
| MT-UR-15-189 | 46 cm (18") |





LIVER GALLBLADDER KIDNEY UROLOGY INSTRUMENTS

Urethrotome, Urethrography- and Circumcision Instruments
Urethrotom, Urethrographie- u. Circumcisions-Instrumente
Uretrótomo, Instrumentos para uretrografía y circuncisión
Urétrotome, Instruments pour uréthrographie et circoncision
Uretrotomi, Strumenti per uretrografia e circoncisione

Otis Urethrotome

With 2 Knives and 3 Tips

| Catalog # | Size |
|--------------|------|
| MT-UR-15-190 | N/A |

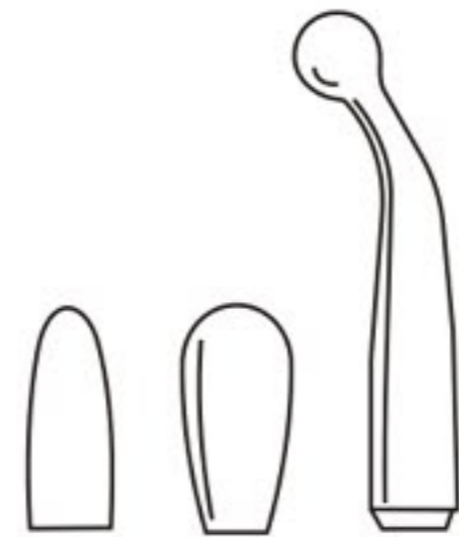

Otis Spare Blade

| Catalog # | Size |
|--------------|------|
| MT-UR-15-191 | N/A |



Filiform Urethral Sound / Dilating Bougie

| Catalog # | Profile |
|--------------|----------|
| MT-UR-15-192 | 3 Charr. |
| MT-UR-15-193 | 4 Charr. |
| MT-UR-15-194 | 5 Charr. |
| MT-UR-15-195 | 6 Charr. |

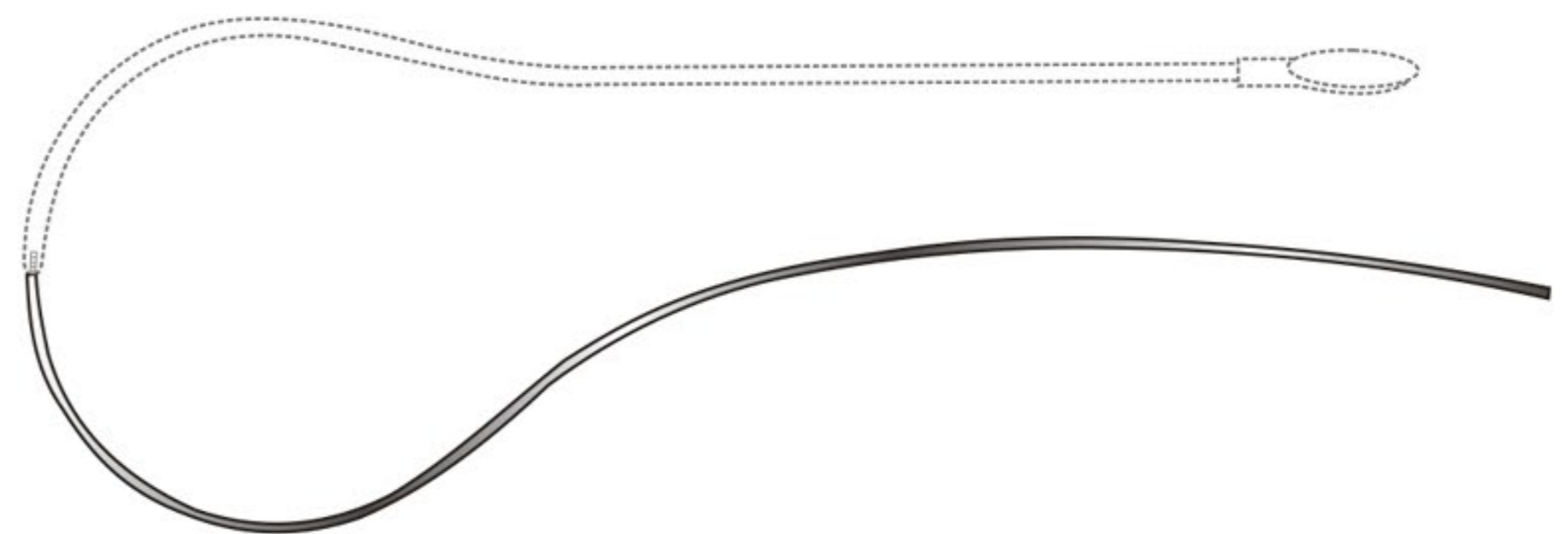

Kuntson Urethrography Instrument

| Catalog # | Size |
|--------------|------|
| MT-UR-15-196 | N/A |





LIVER GALLBLADDER KIDNEY UROLOGY INSTRUMENTS

Circumcision Instruments
Circumcisions-Instrumente
para uretrografía y circuncisión
pour uréthrographie et circoncision
per uretrografia e circoncisione

Gomco Circumcision Clamp

| Catalog # | Diameter |
|--------------|----------|
| MT-UR-15-197 | Ø 8 mm |
| MT-UR-15-198 | Ø 11 mm |
| MT-UR-15-199 | Ø 13 mm |
| MT-UR-15-200 | Ø 16 mm |
| MT-UR-15-201 | Ø 21 mm |
| MT-UR-15-202 | Ø 26 mm |
| MT-UR-15-203 | Ø 32 mm |



Mogen Circumcision Clamp

| Catalog # | Size |
|--------------|-------------|
| MT-UR-15-204 | 7.5 cm (3") |



Mathieu Foreign Body Forcep

| Catalog # | Size |
|--------------|-------------|
| MT-UR-15-205 | 20 cm (8") |
| MT-UR-15-206 | 28 cm (11") |

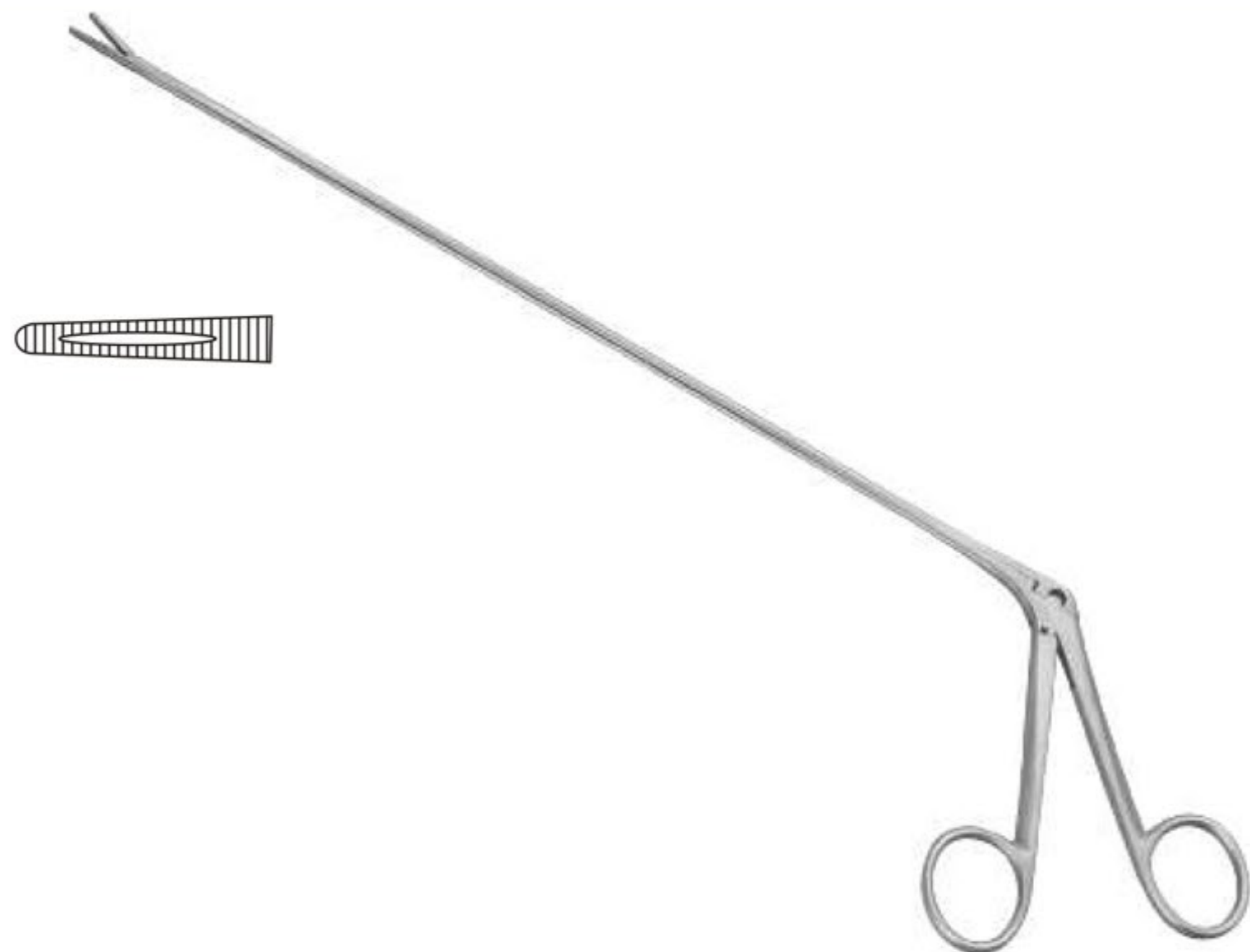

Sachse Meatotome

| Catalog # | Size |
|--------------|------|
| MT-UR-15-207 | N/A |

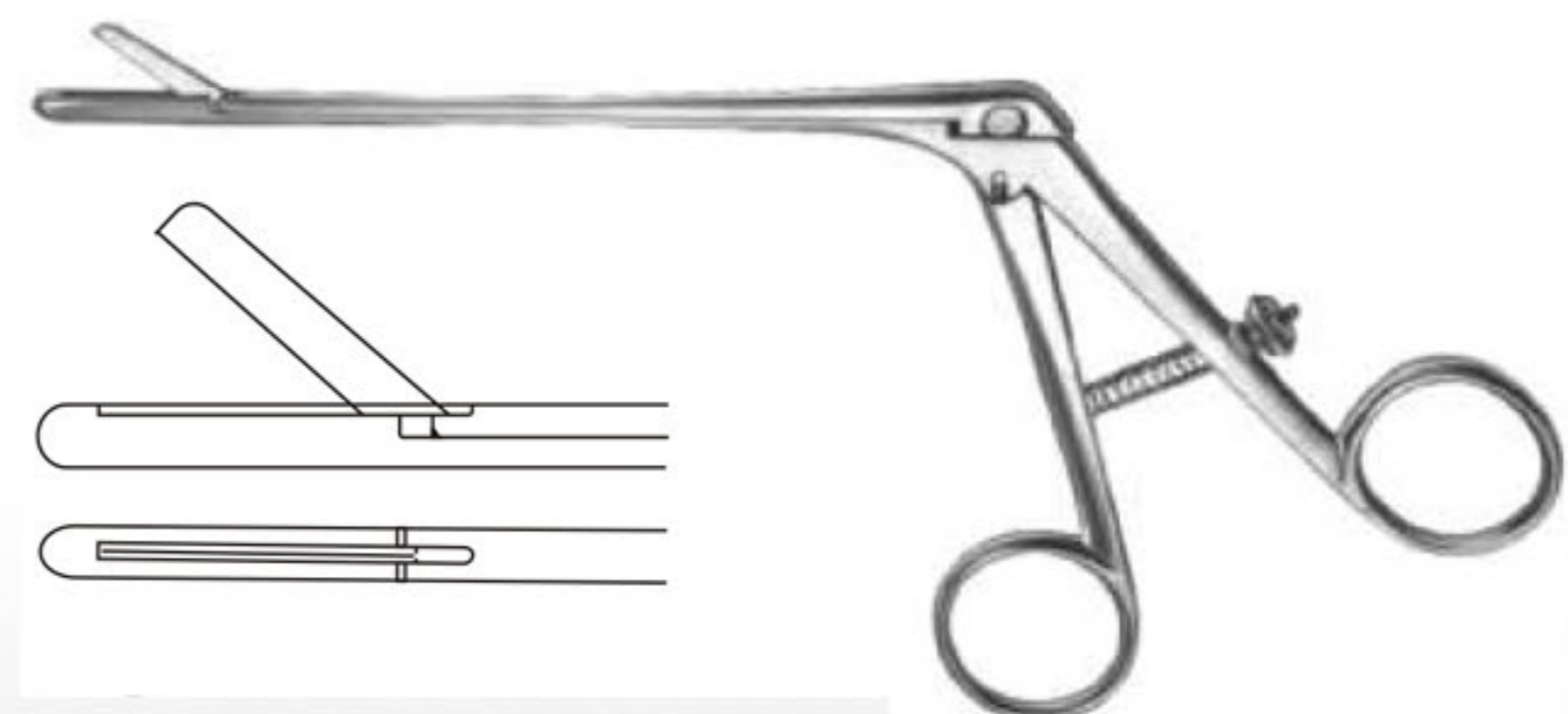



LIVER GALLBLADDER KIDNEY UROLOGY INSTRUMENTS

Circumcision Instruments
Circumcisions-Instrumente
para uretrografía y circuncisión
pour urétrographie et circoncision
per uretrografia e circoncisione

Stockman Penis Clamp



| Catalog # | Size |
|--------------|---------------|
| MT-UR-15-208 | 8 cm (3 1/4") |

Strauss Penis Clamp



| Catalog # | Size |
|--------------|----------------|
| MT-UR-15-209 | 11 cm (4 1/2") |

Coolingwood-Stewart Hernia Ring Forcep



| Catalog # | Size |
|--------------|------------|
| MT-UR-15-210 | 13 cm (5") |

MEDICO TECHNOLOGIES



wazirabad road sialkot- 51310 pakistan



0092 523 571 255



0092 523 571 255



info@medico-medtech.com



<http://www.medico-medtech.com>